

SPECIFICATIONS



- Drop-in / Overmount lavatory sink
- Premium porcelain
- 4" spread faucet holes
- Fits 24" cabinet
- 1 1/2" drain opening
- Template included



PART#	MODEL	COLOR
2644-0317	H-2017-3BK	Black
2646-0319	H-2017-3W	White
2643-0316	H-2017-3B	Biscuit
2645-0318	H-2017-3T	Tan

SINK FEATURES



All HIVE sinks receive expert hands-on care under strict quality control throughout every stage of our modern manufacturing process. This ensures a "NO HASSLE" Limited Lifetime Warranty against all manufacturing defects in material and workmanship under normal use.

CODE / STANDARDS COMPLIANCE

Most HIVE sinks meet or exceed the following specifications:
 ASME 112.19.3-2008 - IAPMO/UPC listed - CSA B45.4-2008

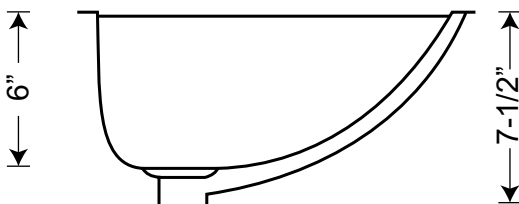
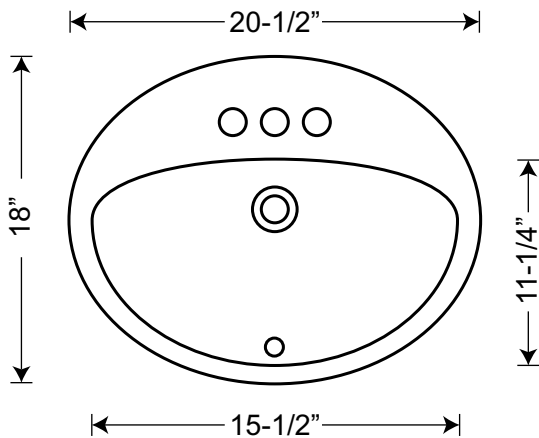

JOB INFORMATION

JOB NAME: _____ MODEL SPECIFIED: _____ QUANTITY: _____
 DATE: _____ ARCHITECT/ENGINEER: _____
 CUSTOMER: _____ CONTRACTOR: _____