









| | | | | | | | |
|--|---|---|---|---|---|---|---|
|  |  |  |  |  |  |  |  |
| SIS-GR106-01 1642-6381 Black Sand | SIS-GR106-02 1643-6382 Wheat | SIS-GR106-03 1644-6383 Iceberg | SIS-GR106-04 1645-6384 Grey Moon | SIS-GR106-05 1646-6385 Chocolate | SIS-GR106-06 1697-9419 Silver Fox | SIS-GR106-07 1698-9410 Storm Cloud | SIS-GR106-08 1699-9411 Eclipse |

Small Single Bowl Bar / Prep Sink

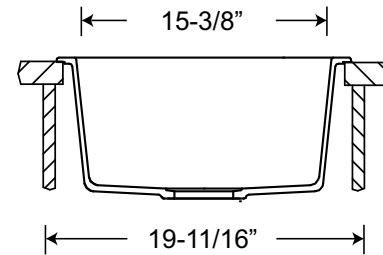
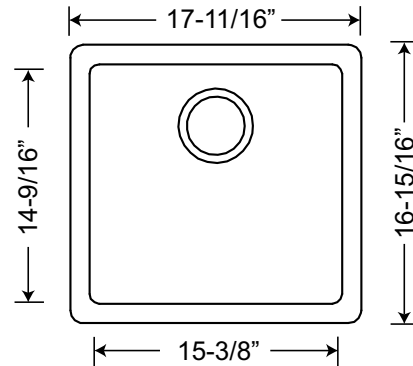

Depth = 7-13/16"

SIS-GR106 - DURAGRANIT SERIES

- 80% quartz and 20% acrylic resins
- Undermount installation
- Scratch and stain resistant
- Heat and acid resistant
- Non-fading
- Easy to clean, extremely hygienic
- Suitable for food preparation
- Fits 21" cabinet
- 3 1/2" drain opening

AVAILABLE ACCESSORIES



SIS-G-GR106
Stainless Steel Grid

QTY



SIS-S01-
Basket Strainer

QTY



SIS-S06-
Disposal Flange

QTY



SIS-GCB1709
Glass Cutting Board

QTY



CODE / STANDARDS COMPLIANCE

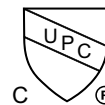

Sinks are listed by IAPMO® as meeting the applicable requirements of the Uniform Plumbing Code®, International Plumbing Code®, and National Plumbing Code of Canada. Product Compliance: CSA B45.5-11/IAPMO Z124-201 including Update No. 1 dated May 2012

JOB INFORMATION

JOB NAME: _____ **MODEL SPECIFIED:** _____ **QUANTITY:** _____

DATE: _____ **ARCHITECT/ENGINEER:** _____

CUSTOMER: _____ **CONTRACTOR:** _____