

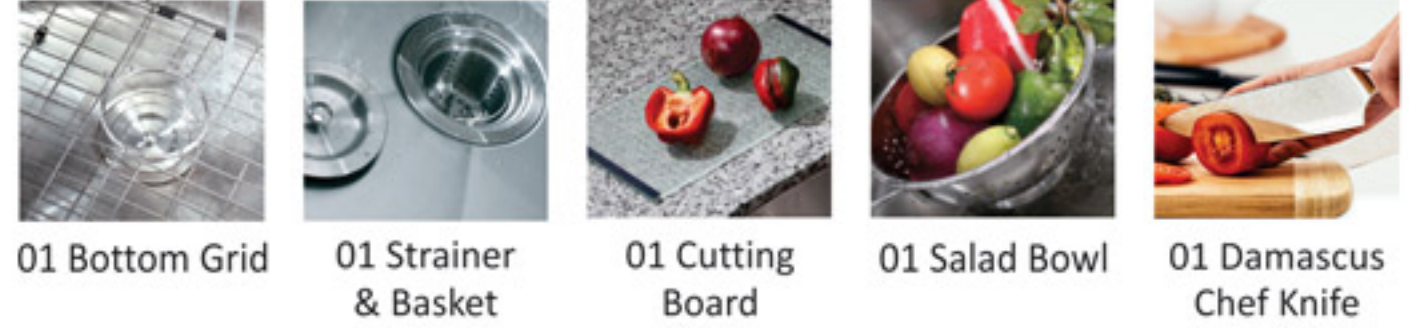

ACCESSORIES INCLUDED



01 Bottom Grid 01 Strainer & Basket 01 Cutting Board 01 Salad Bowl 01 Damascus Chef Knife

This model is made from durable 16 gauge 304 premium stainless steel, highly resistant to heat, most household stains, and rust for the life of the product.

CHEF-Z203 - CHEF SERIES

- Undermount
- 18/8 chrome nickel content
- 15mm radius corners
- Pro-Vest™ undercoat protection over Sound Shield™ pads
- Template and mounting hardware included
- Satin finish - Fits 36" cabinet
- 3 1/2" drain opening

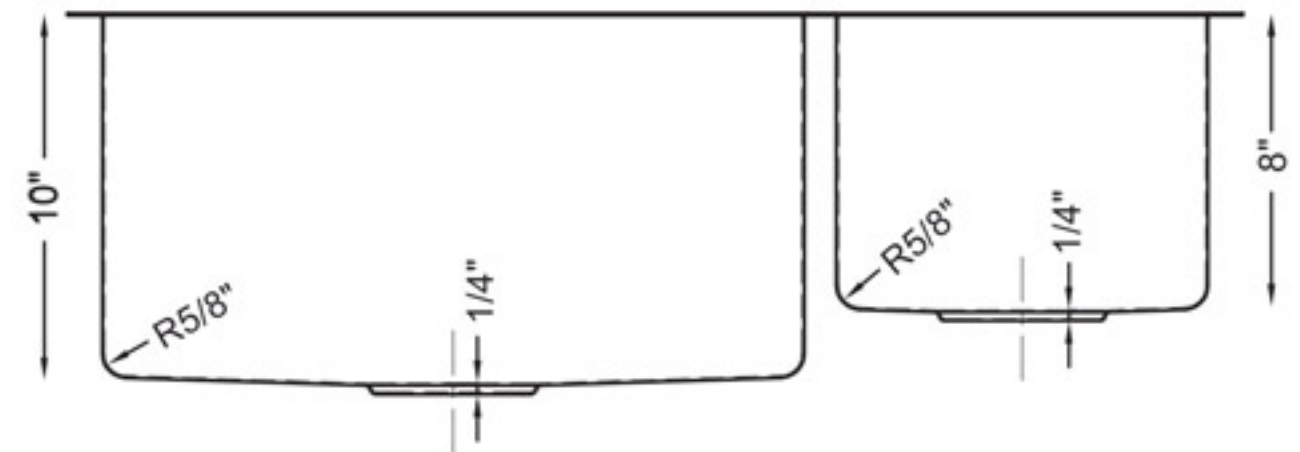
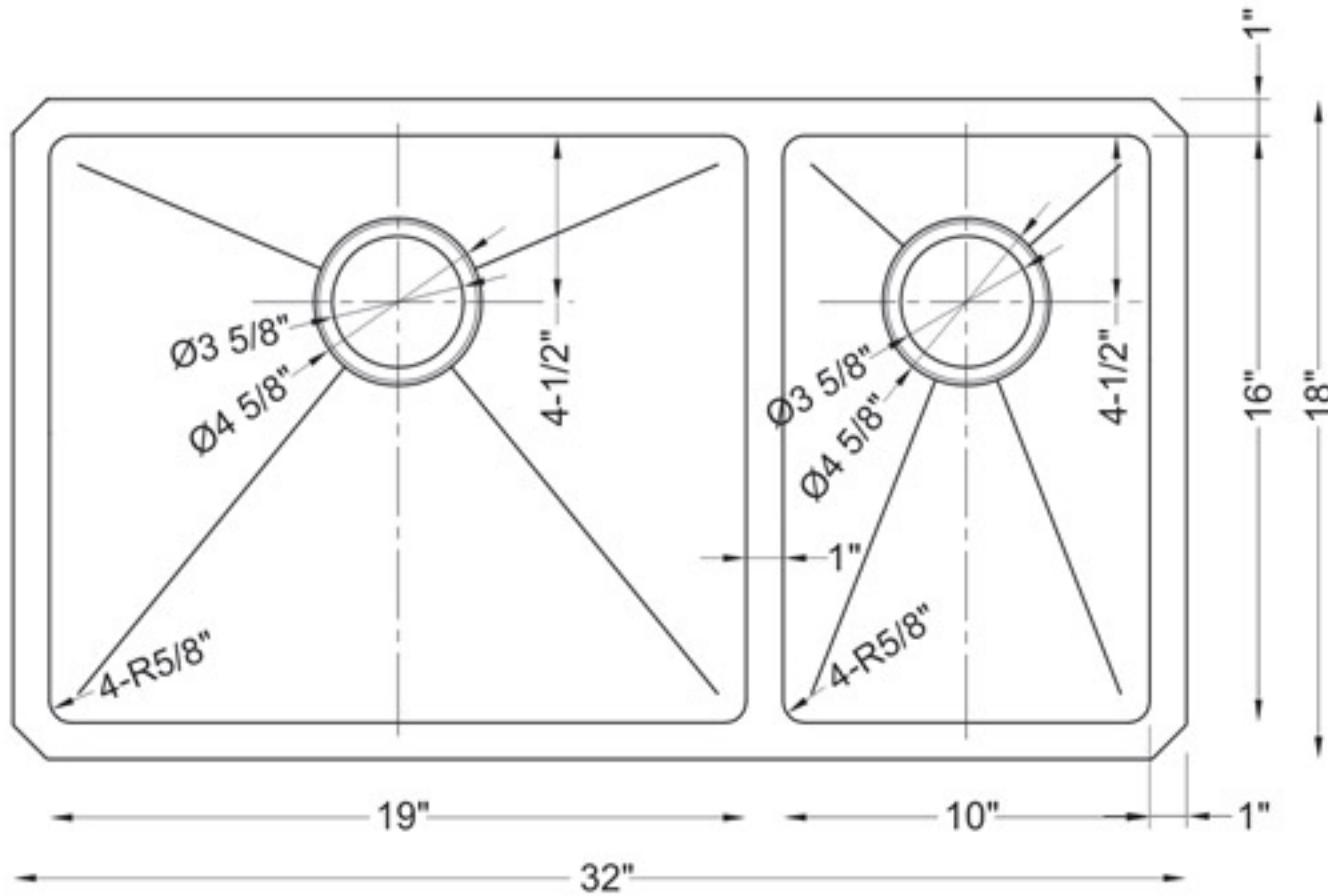

SINK FEATURES



Stone sinks feature Sound-Shield pads on several strategic areas of every sink for extra sound proofing. Made of natural rubber, the Sound-Shield pads reduce the noise of clattering dishes and running water.



Pro Vest is a protective coating over the Sound-Shield pads. This system reduces noise, prevents condensation and helps maintaining water temperature when pre-soaking dishes.



All Stone sinks receive expert hands-on care under strict quality control throughout every stage of our modern manufacturing process. This ensures a "NO HASSLE" Limited Lifetime Warranty against all manufacturing defects in material and workmanship under normal use. Please read our Limited Lifetime Warranty policy at our web site: www.stoneusa.com.

AVAILABLE ACCESSORIES

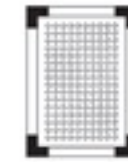

SIS-COLANDER
Stainless Steel
Colander

QTY



JOB INFORMATION

JOB NAME: _____ MODEL SPECIFIED: _____ QUANTITY: _____
 DATE: _____ ARCHITECT/ENGINEER: _____
 CUSTOMER: _____ CONTRACTOR: _____