

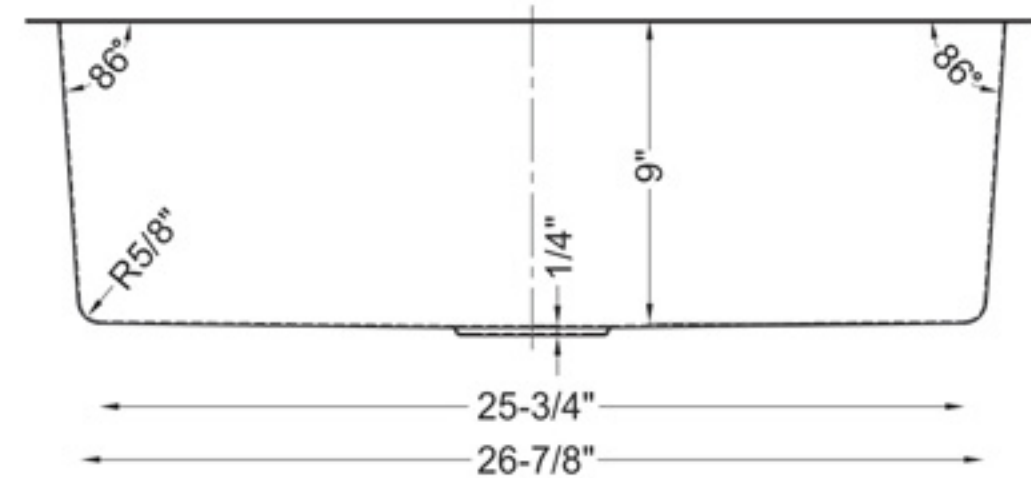

This model is made from durable 18 gauge 304 premium stainless steel, highly resistant to heat, most household stains and rust for the life of the product.

SIS-UZ105X-30 AUVA - UNIVERSE SERIES

- Undermount
- 18/8 chrome nickel content
- 15mm radius corners
- Pro-Vest™ undercoat protection over Sound Shield™ pads
- Template and mounting hardware included
- Satin finish - Fits 30" cabinet
- 3 1/2" drain opening

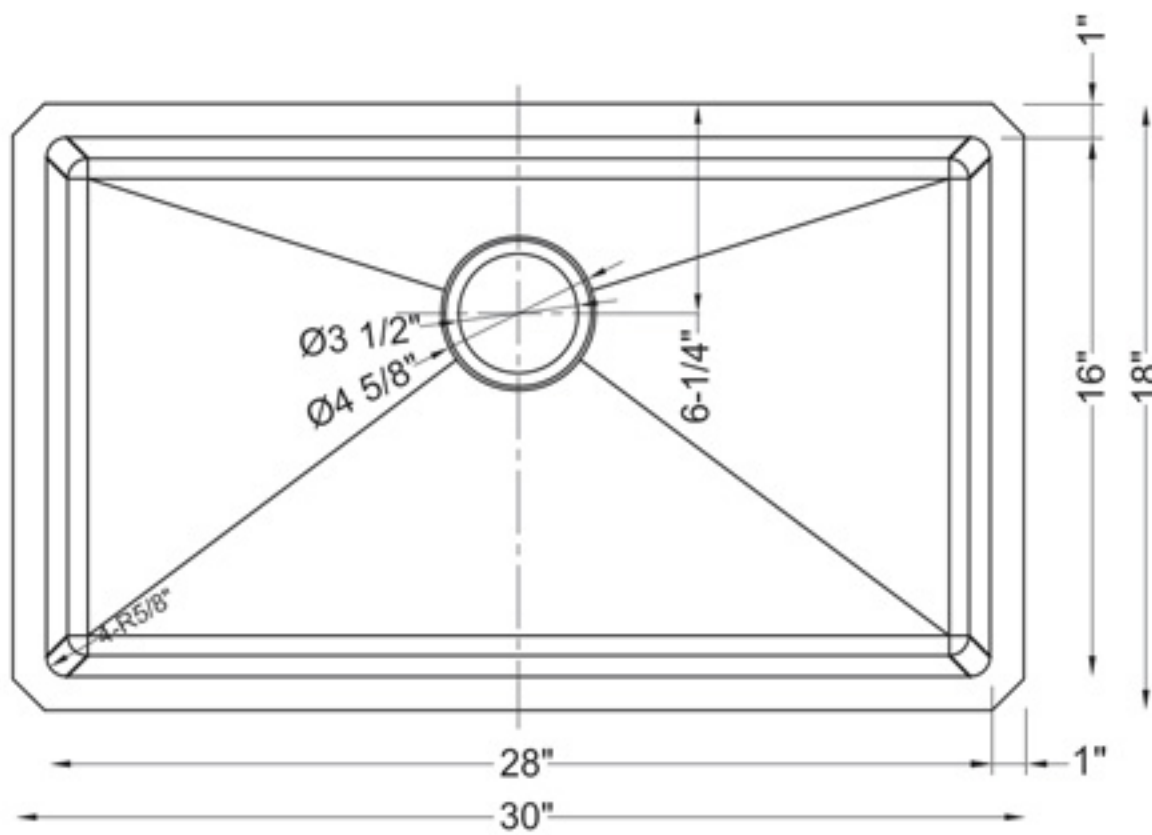

SINK FEATURES



Stone sinks feature Sound-Shield pads on several strategic areas of every sink for extra sound proofing. Made of natural rubber, the Sound-Shield pads reduce the noise of clattering dishes and running water.







Pro Vest is a protective coating over the Sound-Shield pads. This system reduces noise, prevents condensation and helps maintaining water temperature when pre-soaking dishes.

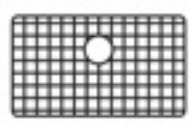

All Stone sinks receive expert hands-on care under strict quality control throughout every stage of our modern manufacturing process. This ensures a "NO HASSLE" Limited Lifetime Warranty against all manufacturing defects in material and workmanship under normal use. Please read our Limited Lifetime Warranty policy at our web site: www.stoneusa.com.

AVAILABLE ACCESSORIES

				
SIS-G-Z105X-30 Stainless Steel Grid Set	SIS-S01-04 Basket Strainer Brushed Nickel	SIS-S06-04 Disposal Flange Brushed Nickel	SIS-S01 Deluxe Strainer & Basket Brushed Nickel	SIS-GCB1709 Glass Cutting Board
QTY <input type="checkbox"/>	QTY <input type="checkbox"/>	QTY <input type="checkbox"/>	QTY <input type="checkbox"/>	QTY <input type="checkbox"/>

JOB INFORMATION

JOB NAME: _____ MODEL SPECIFIED: _____ QUANTITY: _____
 DATE: _____ ARCHITECT/ENGINEER: _____
 CUSTOMER: _____ CONTRACTOR: _____