

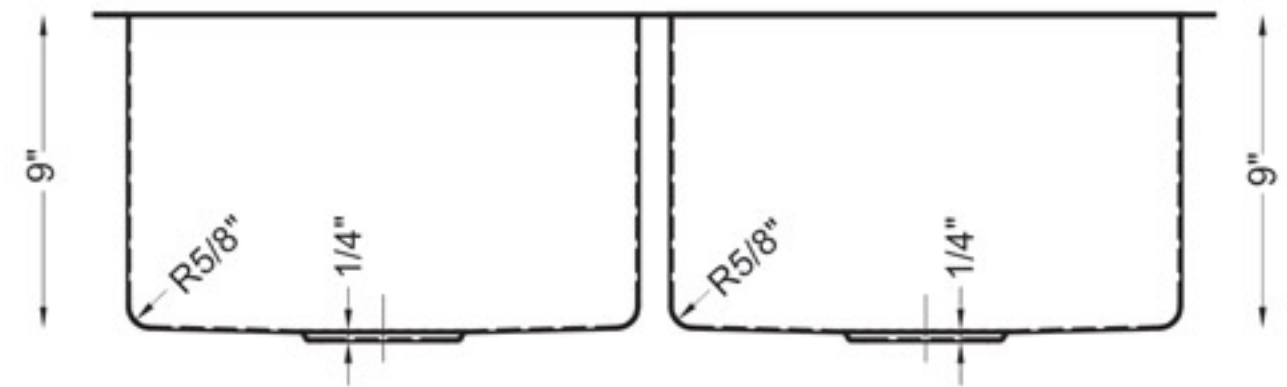

This model is made from durable 18 gauge 304 premium stainless steel, highly resistant to heat, most household stains and rust for the life of the product.

**SIS-UZ202 ENIF - UNIVERSE SERIES**

- Undermount
- 18/8 chrome nickel content
- 15mm radius corners
- Pro-Vest™ undercoat protection over Sound Shield™ pads
- Template and mounting hardware included
- Satin finish - Fits 36" cabinet
- 3 1/2" drain opening

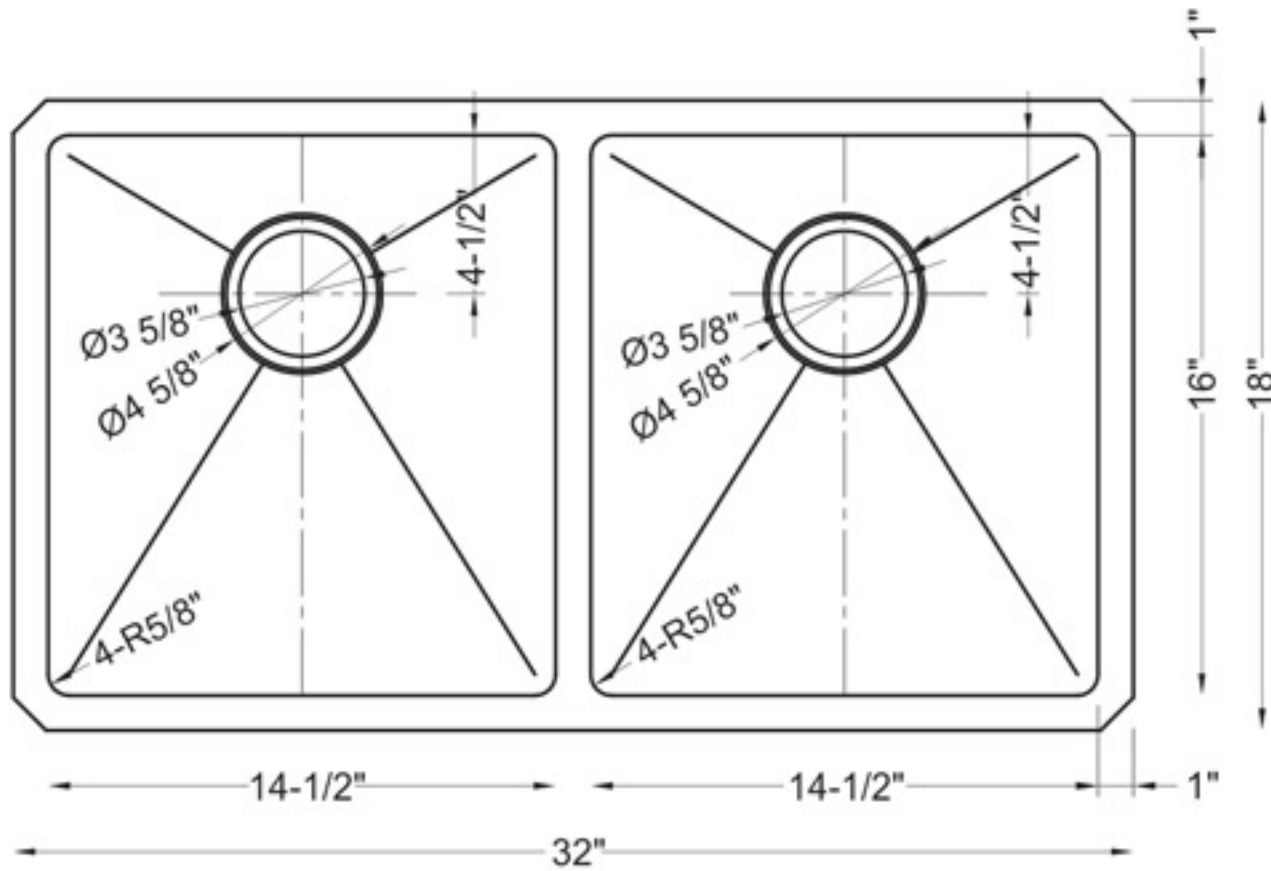

**SINK FEATURES**



Stone sinks feature Sound-Shield pads on several strategic areas of every sink for extra sound proofing. Made of natural rubber, the Sound-Shield pads reduce the noise of clattering dishes and running water.



Pro Vest is a protective coating over the Sound-Shield pads. This system reduces noise, prevents condensation and helps maintaining water temperature when pre-soaking dishes.



All Stone sinks receive expert hands-on care under strict quality control throughout every stage of our modern manufacturing process. This ensures a "NO HASSLE" Limited Lifetime Warranty against all manufacturing defects in material and workmanship under normal use. Please read our Limited Lifetime Warranty policy at our web site: www.stoneusa.com.

**AVAILABLE ACCESSORIES**

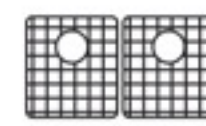

SIS-G-Z202  
Stainless Steel  
Grid Set

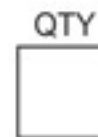

SIS-S01-04  
Basket Strainer  
Brushed Nickel



SIS-S06-04  
Disposal Flange  
Brushed Nickel

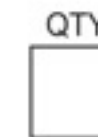

SIS-S01  
Deluxe Strainer &  
Basket Brushed Nickel

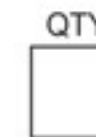

SIS-GCB1709  
Glass Cutting  
Board

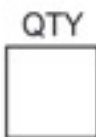

**JOB INFORMATION**

JOB NAME: \_\_\_\_\_ MODEL SPECIFIED: \_\_\_\_\_ QUANTITY: \_\_\_\_\_

DATE: \_\_\_\_\_ ARCHITECT/ENGINEER: \_\_\_\_\_

CUSTOMER: \_\_\_\_\_ CONTRACTOR: \_\_\_\_\_